



TEAM MANAGER'S MEETING

2026 UCI PARA CYCLING ROAD WORLD CUP – GISTEL, BELGIUM - 27 APRIL 2026



Unity. Passion. Integrity. Excellence.



CHAPTER 1

ROLL CALL



Unity. Passion. Integrity. Excellence.



ROLL CALL

PARTICIPATING NATIONS

COUNTRY LIST			
ARG	FIN	KAZ	ROU
AUS	FRA	LUX	RSA
AUT	GER	KSA	SLO
BEL	GBR	MEX	SUI
BRA	GRE	NED	SVK
CAN	HUN	NZL	SWE
CHN	IND	NOR	THA
CZE	IRL	PLE	TUR
DEN	ISR	PER	UKR
EST	ITA	POL	USA
ESP	JPN	POR	UZB





CHAPTER 2
INTRODUCTION



Unity. Passion. Integrity. Excellence.



INTRODUCTION



Local Organising Committee Key Contacts

Alain Demortier – Event Director

Louis Barbeau – Race Director

Robert Declerc – Logistics Manager

Wim Declair – Press/Communications Manager

Jean-Paul Prevot – Security/Safety Manager

Dirk De Jonghe – Secretariat Hotel

INTRODUCTION



UCI Key Contacts

- **Todd Fraser (UCI) - Para Cycling Manager**
- **Roberto Rancilio (ITA) – Technical Delegate**
- **Paul Watson (IRL) – President of Commissaires Panel**
- **Erik Moen (USA) – Chief Classifier**

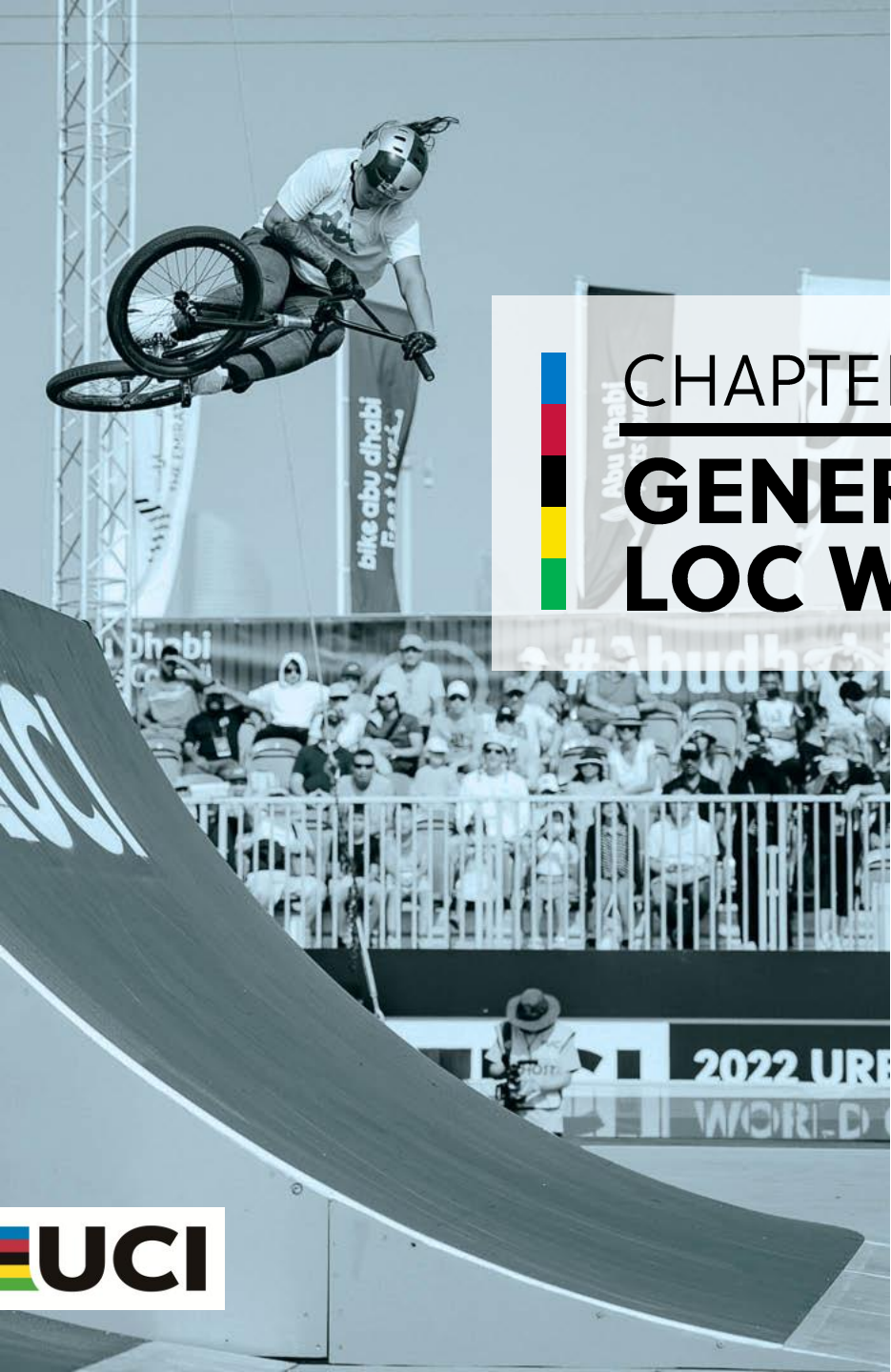

CHAPTER 3



GENERAL INFORMATION AND LOC WELCOME



Unity. Passion. Integrity. Excellence.



GENERAL INFORMATION

WELCOME

- **LOC Gistel 2026 Para Cycling Road World cup**
 - **Mr Alain DEMORTIER**





CHAPTER 4

TECHNICAL UPDATE



Unity. Passion. Integrity. Excellence.



COURSE – TT

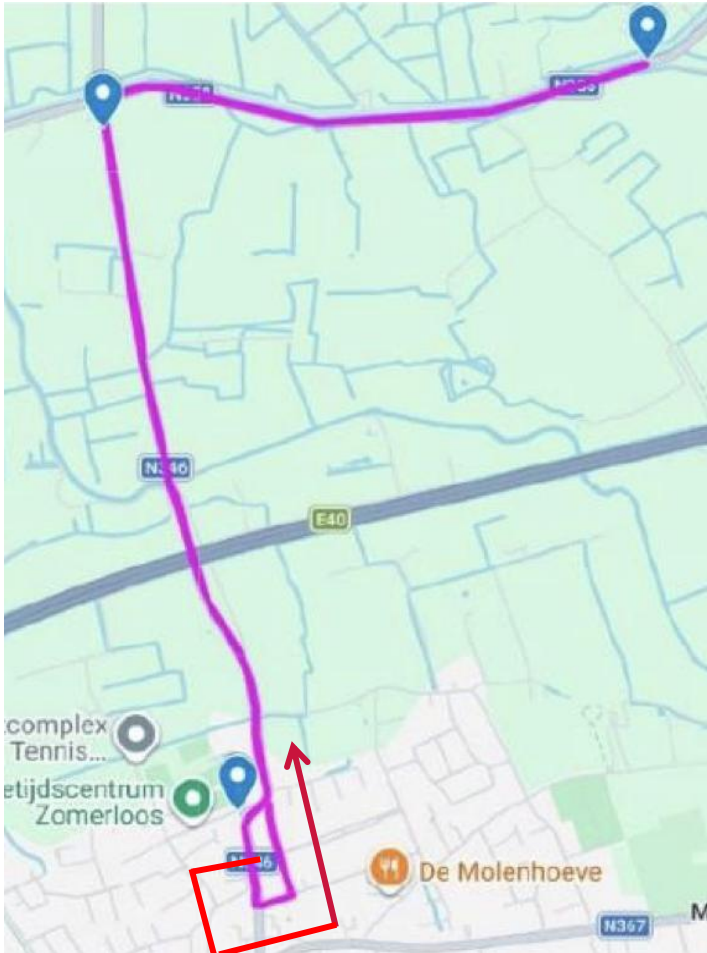

- Length 10,2 km
- No team cars allowed
- Teams can provide service by foot
- Athletes after finish slow down and exit straight ahead at 1st turn (pay attention to other riders)

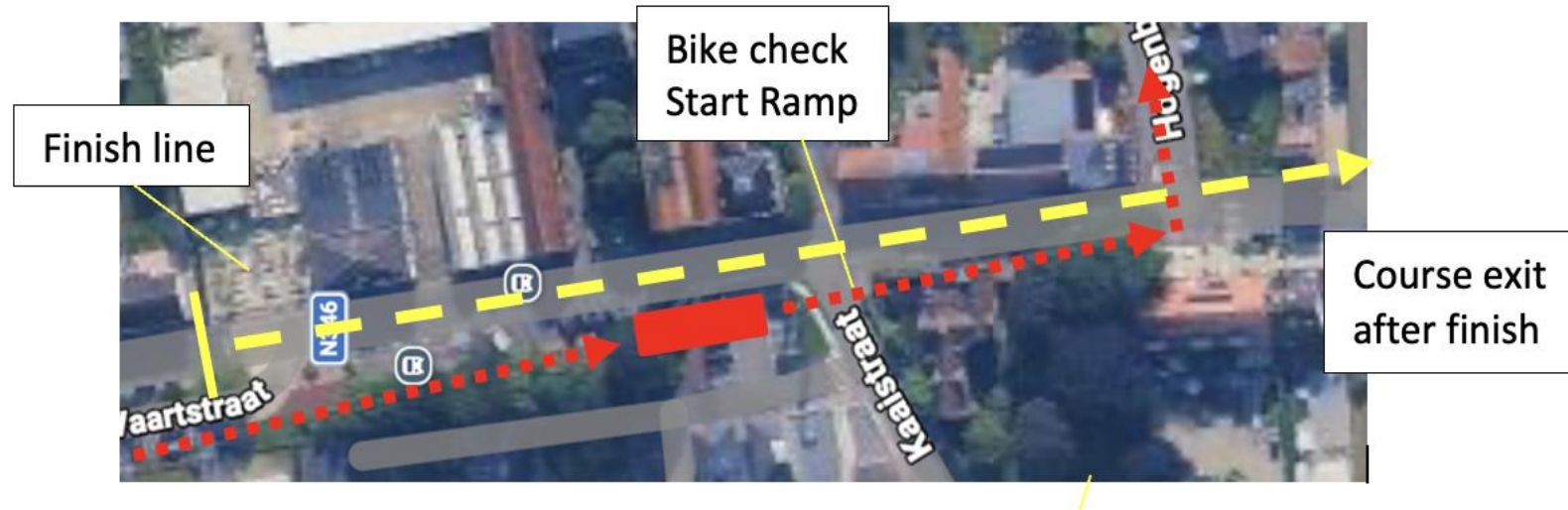

COURSE – RR

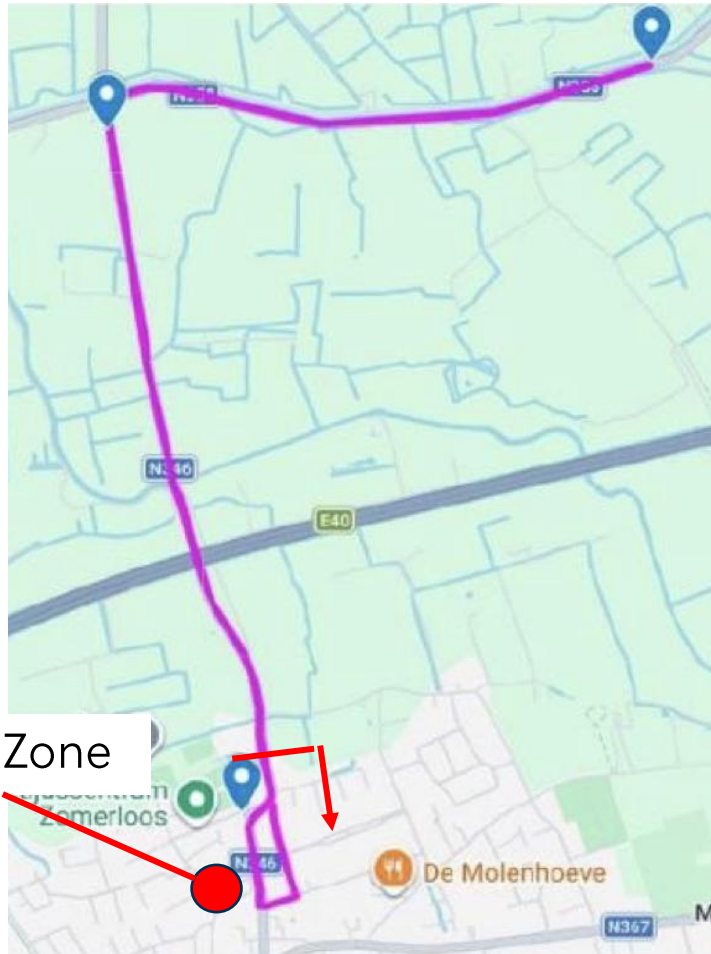

- Length 10,2 km
- Race direction opposite TT
- Feed/Green/Tech zone at TT start area (signals)
- Attention --> Start specific procedure
- C1-2-3 holders --> do not carry itms!

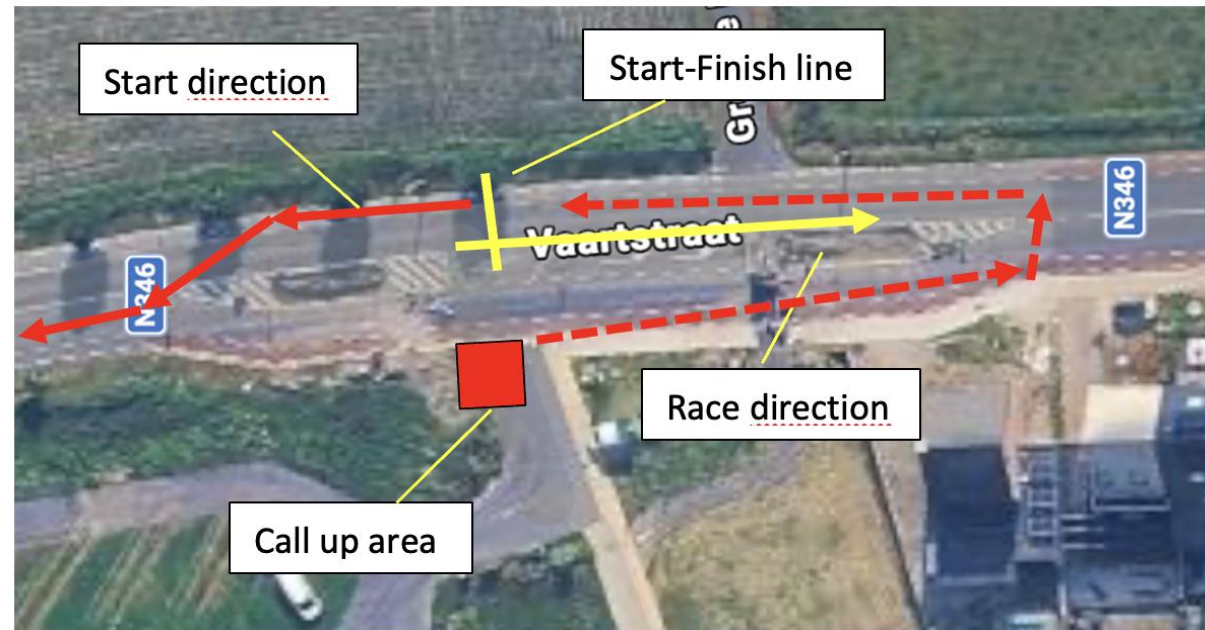



CHAPTER 5

COMMISSAIRE UPDATE



Unity. Passion. Integrity. Excellence.



COMMISSAIRE UPDATE

MEMBERS OF THE COMMISSAIRES PANEL

President of the Commissaires Panel

Paul Watson (IRL)

Secretary

Ludo Smeyers (BEL)

Members

Alain Koszyczarz (FRA)

Alexandre Nouhaud (FRA)

Technical Commissaire

Christian Magiera (GER)

National Commissaires Appointed by Belgian Cycling

Jan Weymeersch

Gabriel Termont

Krist Brulez

Wim Deblaere

David Delva

Lieven Van Landegem

Peter Lauwagie

Vincent Van Impe

Kris Van Steen

Sabrine Van Houte

Freddy Van Steen

Pascal De Laere



COMMISSAIRE UPDATE

- UCI Rules (Part I, II, XVI) & **UCI penalty scale**
- Commissaires Communique – please read
- Daily Communiques, including start lists

- For RR & TT - Safety Bars securely fitted, to both Handbikes and Trikes
- Bike plates, numbers and transponders correctly fitted
- For ITT, Race numbers can be placed in transparent pockets
- For RR Race numbers must be fitted to the outside of the jersey not in pockets
- For Handbikes for ITT & RR place place numbers on both sides – left and right (Leg or Bike)
- For Team Relay numbers on the right leg

COMMISSAIRE UPDATE

- For ITT, Pre-Checks for bike
 - Tuesday 9.00 – 9.45 - Session 1
 - Tuesday 13.00 - 13.45 - Session 2
- Wednesday Pre Checks 09.00 - 9.45
- For ITT, race bike checks 10` prior to the start – riders must also present at this time in race attire
- Call Up RR 10` prior to start – riders must be there when their name is called or be placed at back of grid
- Victory Ceremony (Race clothing, race shoes or trainers, NO headbands or sunglasses)
- **No Following Cars in TT**

COMMISSAIRE UPDATE



- Helmet Colours – for Road defined in 16.10.002
- Wrong coloured Helmet – Not allowed to start – withdrawn and Disqualified
- Silver Helmets are not White !!!!

- Call up/Start Order Clarification
- As per other World Cups

COMMISSAIRE UPDATE



Request for assistance:

Racing and overall

- Paul Watson
- Roberto Rancilio
- Todd Fraser

Secretarial and results

- Ludo Smeyers
- Sylvain Richard

Equipment and technical

- Christian Magiera

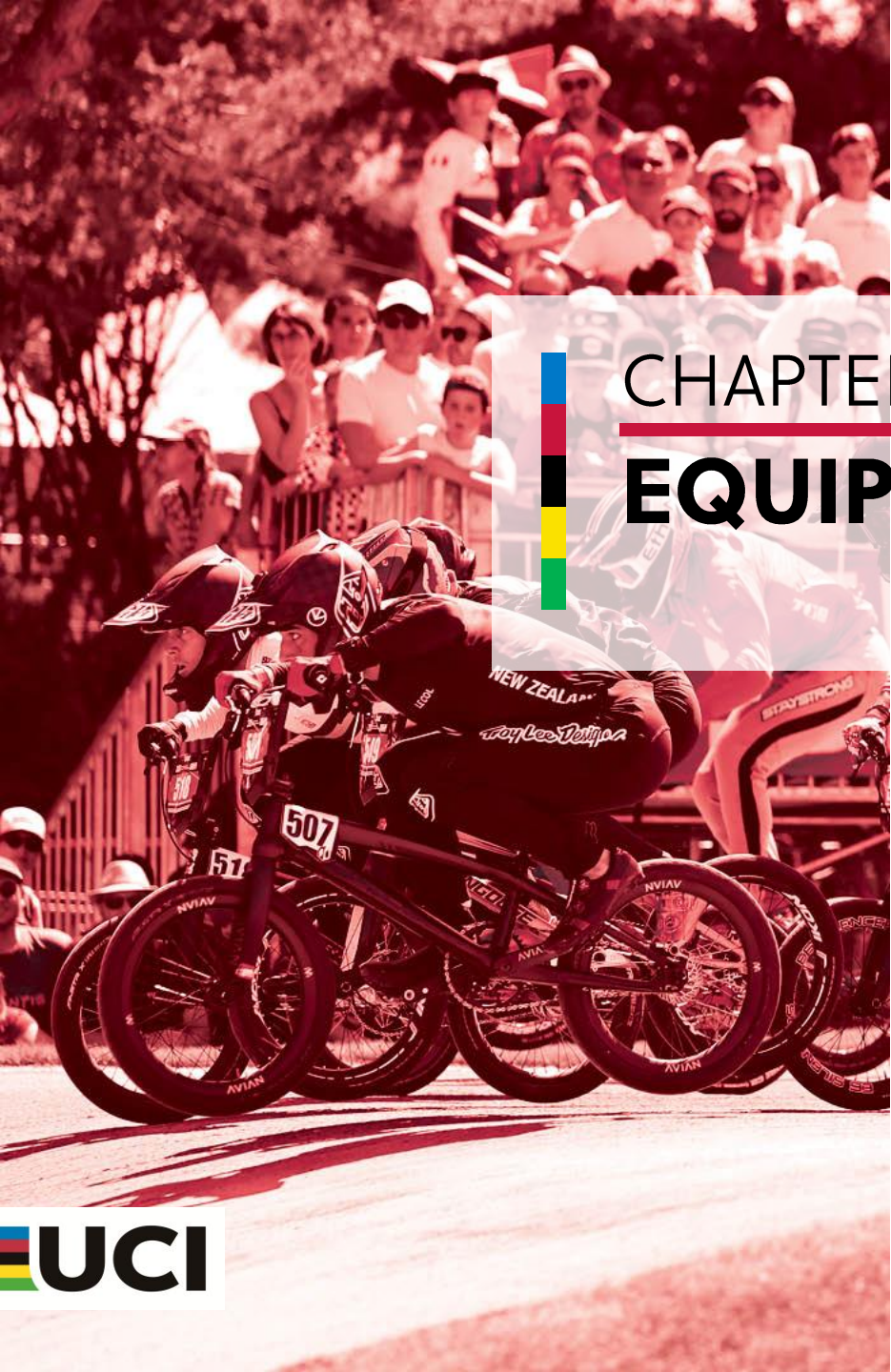

CHAPTER 6

EQUIPMENT UPDATE



Unity. Passion. Integrity. Excellence.



6.1

ROAD RACES

HANDLEBAR WIDTH

ROAD RACES



ROAD RACE HANDLEBAR CHECKS

How :

- With UCI 3d Printed Tools
- Check Levers inner distance (280mm)
- Check Drops overall distance (400mm)
- Check Levers angle (10°)

If non compliant – must be corrected to take start

- Bikes can be rechecked at finish – to ensure still compliant

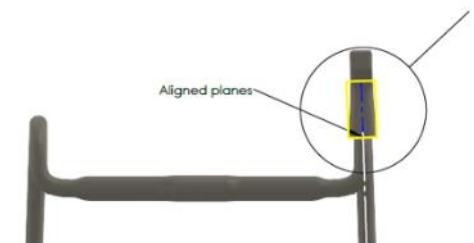
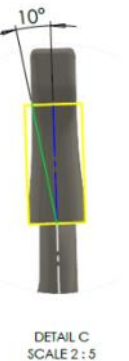
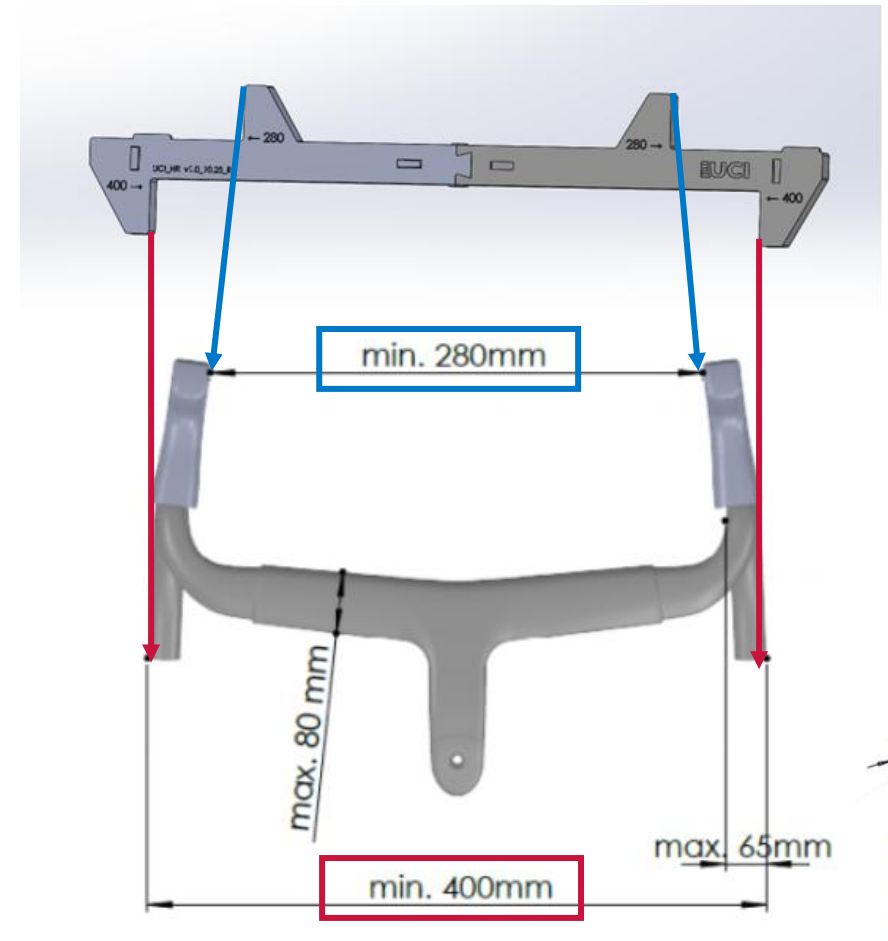

HELMET

ROAD RACES

ROAD RACE HELMET CHECKS

How :

- VISUAL CHECK of 3 criteria :
 - Minimum 3 air inlet openings
 - Ears must not be covered
 - No integrated or detachable visor



Some helmet models may be compliant for one rider and non-compliant for another (e.g. covered or uncovered ears)

If in doubt – get checked the day before to ensure compliance



* Helmet : KASK Nirvana

- Minimum 3 air inlet openings
- Ears not covered
- No integrated or detachable visor

Decision for this rider :

RIM HEIGHT AND APPROVED WHEELS

ROAD RACES



ROAD RACE RIMS MAX PERMITTED 65mm Rim Only

How :

- VISUAL CHECK of rim height (max. 65mm)
- Verification with the UCI List of Approved Wheels
- IF NECESSARY : Measurement of the rim height

Any concerns – talk to Technical early – do not leave to just before the start.

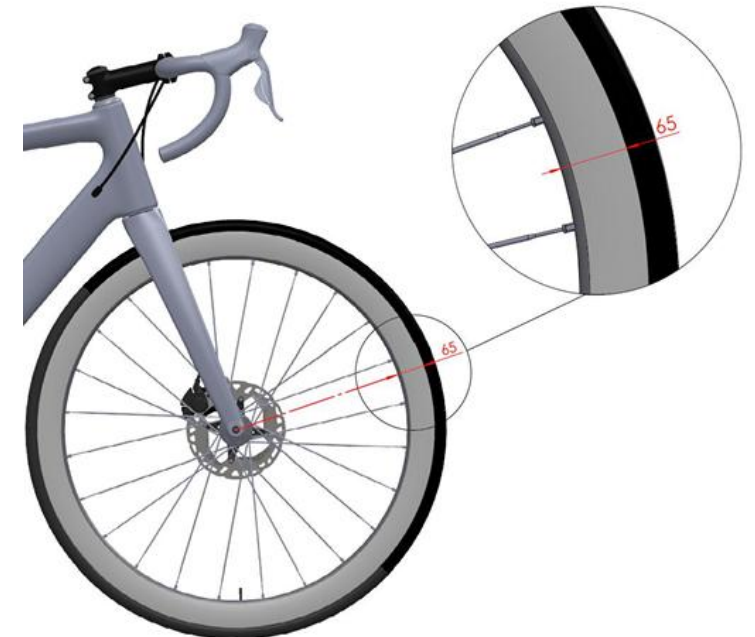

RIDER'S POSITION

ARTICLE 1.3.008

Position

- 1.3.008** The rider shall normally assume a sitting position on the bicycle. This position requires that the only points of support are the following: the feet on the pedals, the hands on the handlebars and the seat on the saddle. **Furthermore, the rider must ensure firm control over the bicycle at all times.**

(text modified on 01.01.09; 01.01.26)



NON-ESSENTIAL EQUIPMENT

ROAD RACES



No Modifications to Body Shape with Non Essential Items

How :

- VISUAL CHECK of riders during races
- ANY BREAKING OF THE REGULATIONS WILL BE DEALT WITH UNDER UCI PENALTIES

This can include Bottles in the Road Race and Radios in the Time Trial as well as any other equipment



6.2

HANDCYCLES & TRICYCLES

NEW Measuring Mat will be in Belgium

MEASUREMENT MAT

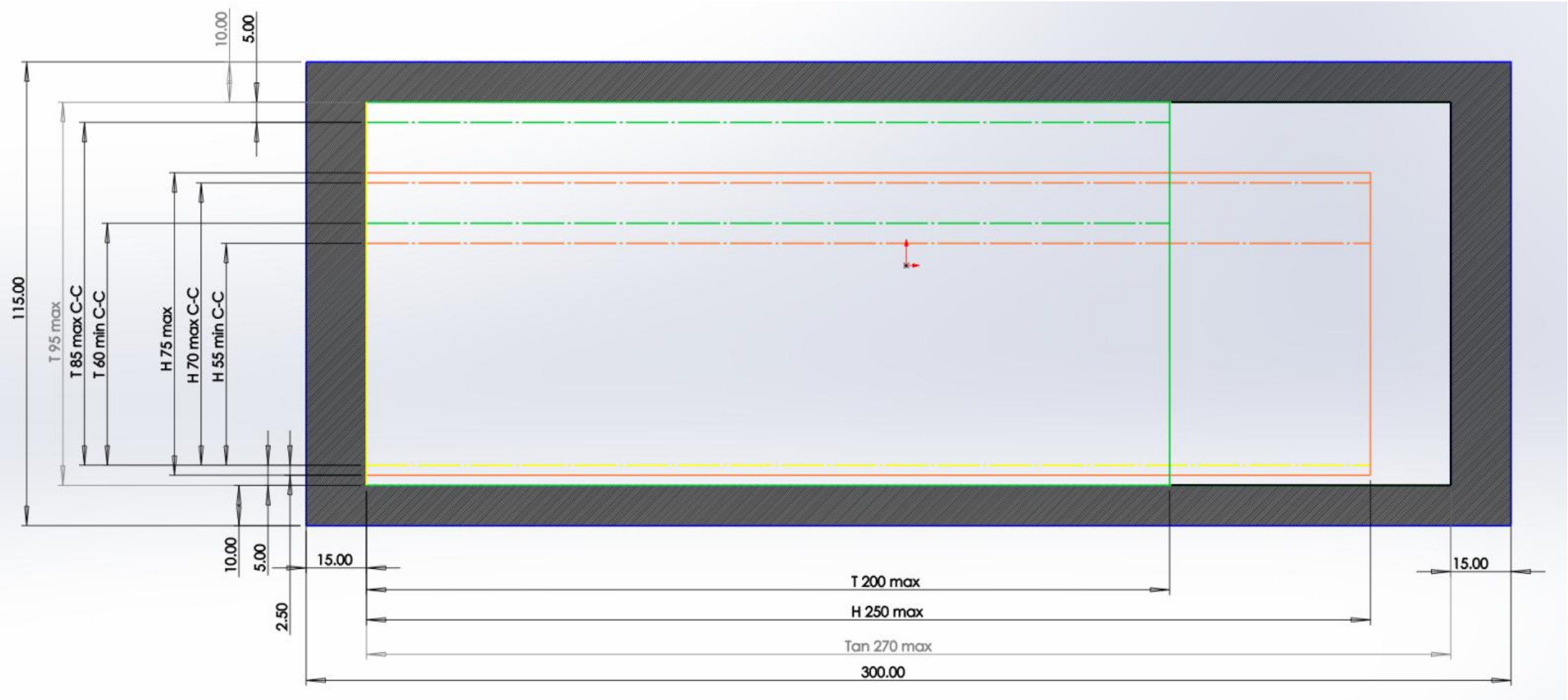

6.3

TIME TRIAL

BIKE CHECKS

ARTICLE 2.4.010 & 2.5.009 TIME TRIAL REQUIREMENTS

Start

2.4.010 All riders shall present themselves with their equipment at the bike check area no later than 10 minutes before their scheduled start time. This check is mandatory and must be passed before the rider is allowed to start. After this final check, riders must remain within the controlled area, composed of the bike check, warm-up and waiting areas, until their start.

An optional pre-check session may be made available by the Commissaires at a designated time earlier in the day or the day before. This session is informal and intended to assist teams with the preparation of equipment. No decisions shall be made on the right to use equipment or not and the pre-check shall not replace the mandatory final check.

(text modified on 01.01.04; 01.07.11; 01.07.12; 01.01.26).

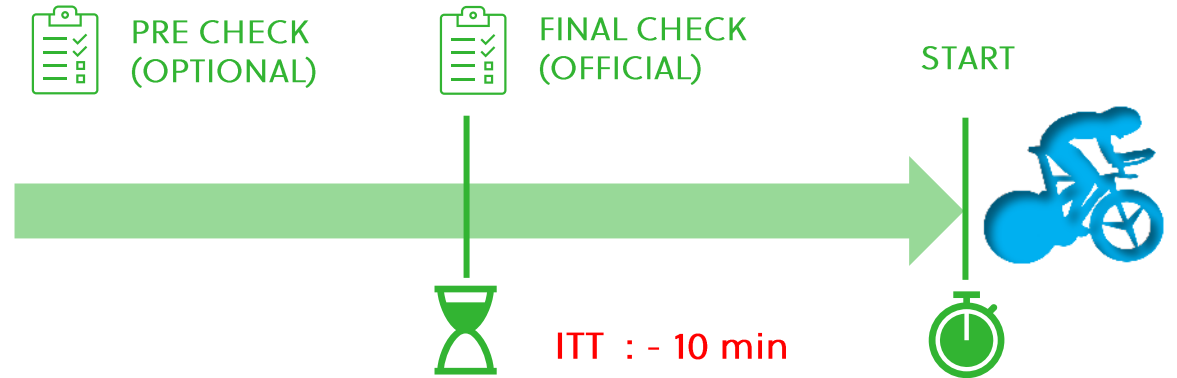

9. Specific sanctions for time trials			
9.2 Bicycles and equipment not presented for checking at least 10 minutes before a rider's start time in an individual time trial, and 15 minutes before a team's start time in a team time trial.	<u>Rider:</u> CHF 500 fine per rider involved <u>Sport Director:</u> CHF 500 fine per rider involved	<u>Rider:</u> CHF 200 fine per rider involved <u>Sport Director:</u> CHF 200 fine per rider involved	<u>Rider:</u> CHF 50 fine per rider involved <u>Sport Director:</u> CHF 50 fine per rider involved

TT Modifications and Regulations



No Modifications to Body Shape with clothing – shoelaces or socks as some examples

How :

- VISUAL CHECK of riders before and during races
- ANY BREAKING OF THE REGULATIONS WILL BE DEALT WITH UNDER UCI PENALTIES

Also Visors with fairings not allowed in TT

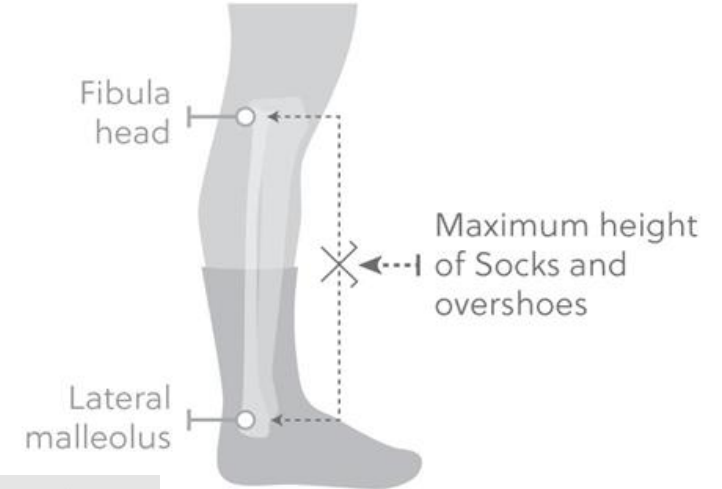



UCI UPDATE



Unity. Passion. Integrity. Excellence.



REASSESSMENT AFTER OBSERVATION



16.4.016

Following an Observation Assessment, the Classification Panel may require the Athlete to redo any prior stages of the Evaluation Sessions. The Classification Panel cannot, based on the results of the Observation Assessment alone, allocate the Athlete a Sport Class that is different from the one provisionally allocated.

This article was modified to align with the 2025 IPC Classification Code.

Please note this may cause delays and/or postponement of medal ceremonies.

WORLD CUP LEADERS JERSEY PRESENTATION



Current World cup leaders are required to wear the leaders jersey during the RR.

Leaders Jersey will be presented ceremonially at the end of the Road Races.

If the world cup leader at the end of this competition is not a medallist from the sports classes' race, he/she must be present at the ceremony to receive the World Cup leaders jersey separately.

CAMERAS ON BIKES



No image capturing device on the rider or bicycle during racing

This includes Oakley Meta Glasses or similar devices (without prior approval)

No approval has been given for this round of the UCI Para Cycling Road World cup

SOCIAL MEDIA



Media working with teams - Contact benjamin.gilbert@uci.ch

#	X	f	📷	▶	🎵
#ParaWorldCup	UCI_Paracycling	UCI	uci_cycling	ucichannel	uci_cycling

Team Information - Gistel Para Cycling Road World Cup

Groupe WhatsApp



UCI TECHNICAL EQUIPMENT MEETING



Tomorrow 28 April at 19:00 in the upstairs room (Oosdeip 1) near classification.

Not mandatory

Update and conversation about the future of tech rules and adaptations related to para cycling.

LA28 QUALIFICATION SYSTEM WEBINAR



To review the qualification criteria for the Paralympic Games, please visit the IPC website: [Paralympic Games Los Angeles 2028 – Qualification criteria](#)

A separate document is also available detailing the system.

Should you have any questions please feel free to reach out at any time.



QUESTIONS



Unity. Passion. Integrity. Excellence.



BIB NUMBERS AND TRANSPONDERS

COUNTRY LIST			
ARG	FIN	KAZ	ROU
AUS	FRA	LUX	RSA
AUT	GER	KSA	SLO
BEL	GBR	MEX	SUI
BRA	GRE	NED	SVK
CAN	HUN	NZL	SWE
CHN	IND	NOR	THA
CZE	IRL	PLE	TUR
DEN	ISR	PER	UKR
EST	ITA	POL	USA
ESP	JPN	POR	UZB





THANK YOU!



Unity. Passion. Integrity. Excellence.